



FLOWELL



Website : www.flowellpneumatics.in
E-mail : info@flowellpneumatics.in



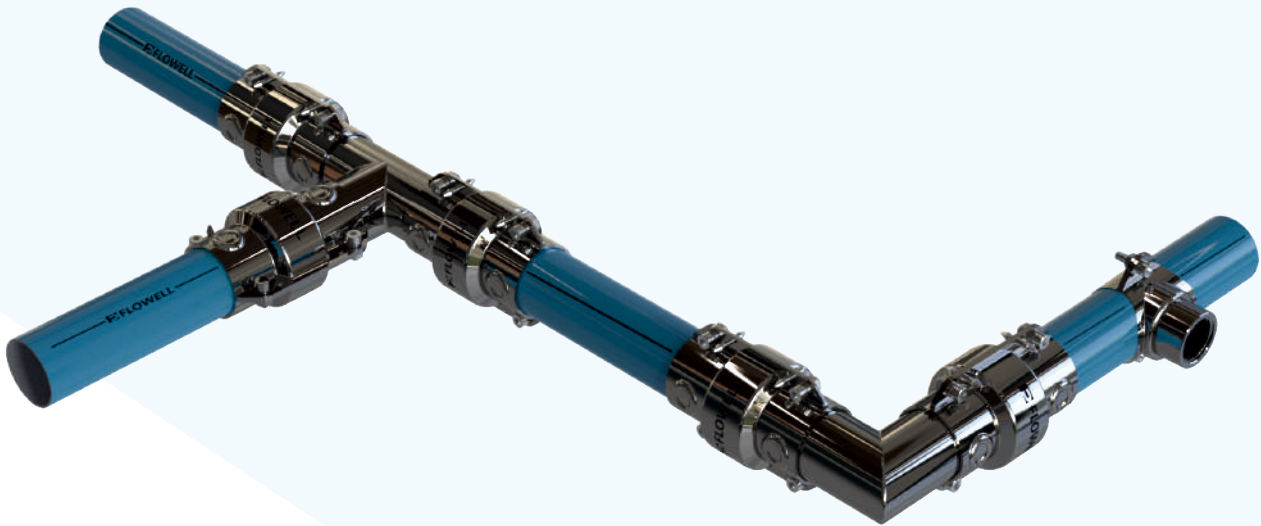

FLOWELL PNEUMATICS PVT LTD provides the complete compressed air piping solution with excellent operational efficiency and perfect suitability for various industrial applications at competitive cost.

FLOWELL piping system stays ahead in competition when it comes to reliability, rigidity, quality and durability. Our system is modular and corrosion free, it meets the highest industrial standards and has 10 years warranty.

FLOWELL solid metal piping system offers you simple design and substantial strength which ensures easy installation. It is an excellent choice for compressed air/vacuum and inert gases for distribution up to 16 bar/-0.87 bar operating pressure in the temperature range -20°C to 75°C.

The smoother interior construction of extruded aluminium pipe 6063-T6 and SS-304/316-L seamless pipe has low coefficient of friction and full bore fittings which minimizes the pressure loss and provide best laminar flow & leak free connections are preventing air loss/wastage.



ISO 9001:2015

CE CONFORMITY
FPPL Products Conform the CE
to maintain the required level of safety.



FPPL Products Meet The Requirements of
ASME B31.3 Standard

PATENTED SEALING



10 YEARS WARRANTY FOR
GEM / ACE / ACE+ RANGES

FPPL PRODUCTS ARE
FIRE RESISTANT



Flowell Pneumatics Pvt. Ltd., has introduced three range of compressed air & inert gas piping systems.

GEM – Aluminum Pipes with SS 202 fittings for General Industrial applications.

ACE – SS 304 Pipes with SS304 fittings for Food and Beverage applications.

ACE Plus – SS 316L Pipes & SS 316L fittings specially for Pharmaceutical applications.

NPS	½"	1"	1 ½"	2"	2 ½"	3"	4"
Size	φ21	φ33	φ48	φ60	φ73	φ90	φ114

TECHNICAL CHARACTERISTICS FOR ACE SERIES

- **Diameters (in mm)**
21-33-48-60-73-90-114
- **Max working temp**
-20°C to 75°C
- **Max working pressure**
16 bar : For sizes 21, 33, 48, 60
13 bar : For sizes 73, 90, 114
- **Vacuum level**
-0.87 bar
- **Pipe material**
SS 304 ERW/Seamless Pipes, Conforming to EN 10217-7, EN 10216-1
- **Pipe fittings material**
SS 304
- **Sealing material**
NBR / Silicone
- **Standard**
FLOWELL ACE Series products meet the requirements of ASME B31.3
- **Standard Finish of Pipe**
For Air - Matte Finish
For GAS - Matte Finish with respective standard gas colour radium lining
- **Compatibility**
Compatible with all Compressor oil / Oil free compressed air, Industrial vacuum, Nitrogen and Inert gases.

SS 304 - Seamless Pipe



Part Number	Size	Length
FPP-4-21-5.8	21	5800
FPP-4-33-5.8	33	5800
FPP-4-48-5.8	48	5800
FPP-4-60-5.8	60	5800
FPP-4-73-5.8	73	5800
FPP-4-90-5.8	90	5800
FPP-4-114-5.8	114	5800

Coupling-SS 304

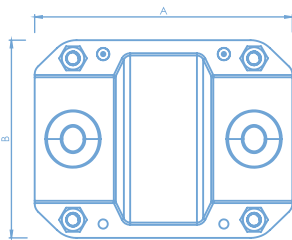
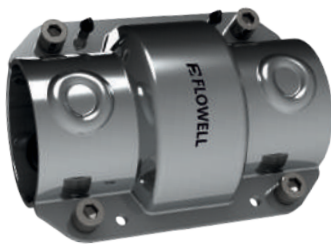

Part Number	Size	A	B
FPC-4-21	21	94	52
FPC-4-33	33	100	64
FPC-4-48	48	111	85
FPC-4-60	60	118	115
FPC-4-73	73	142	120
FPC-4-90	90	168	141
FPC-4-114	114	185	196

Male Adaptor – SS 304

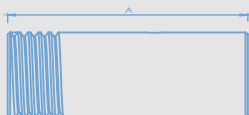

Part Number	Size	A
FPMA-4-21	21	85
FPMA-4-33	33	95
FPMA-4-48	48	100
FPMA-4-60	60	105
FPMA-4-73	73	120

Bend – SS 304

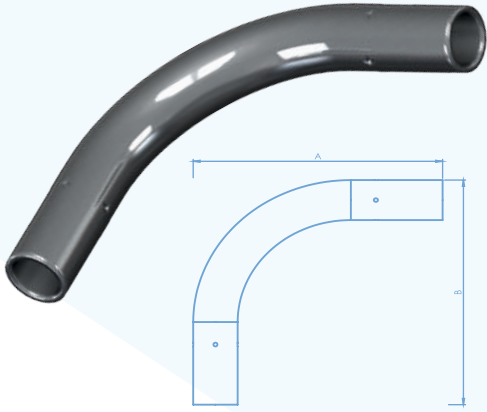

Part Number	Size	A	B
FPB-4-21	21	120	120
FPB-4-33	33	162	162

Female Threaded Elbow – SS 304

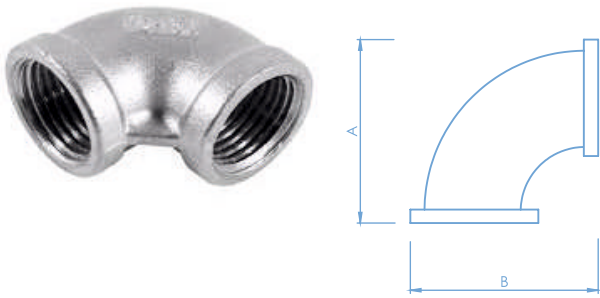

Part Number	A	B
FPTE-4-21	43	43
FPTE-4-33	56	56

Elbow – SS 304

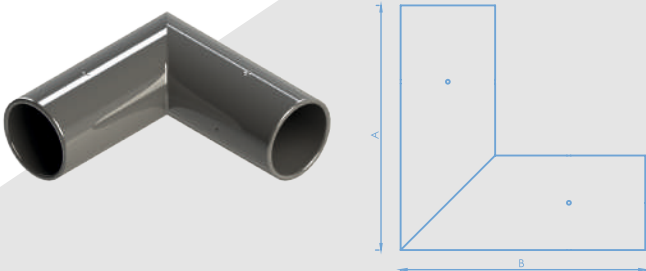

Part Number	Size	A	B
FPE-4-48	48	125	125
FPE-4-60	60	145	145
FPE-4-73	73	170	170
FPE-4-90	90	205	205
FPE-4-114	114	235	235

Tee – SS 304

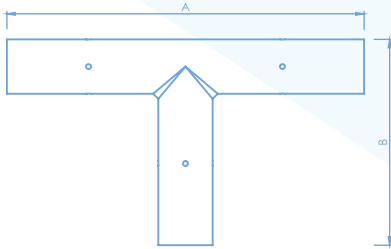
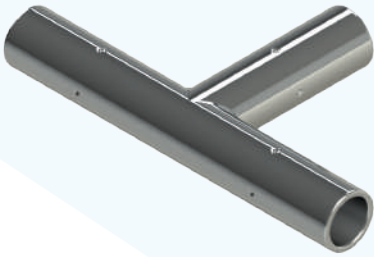

Part Number	Size	A	B
FPT-4-33	33	180	105
FPT-4-48	48	200	125
FPT-4-60	60	230	145
FPT-4-73	73	265	170
FPT-4-90	90	320	205
FPT-4-114	114	355	235

Reducing Tee – SS 304

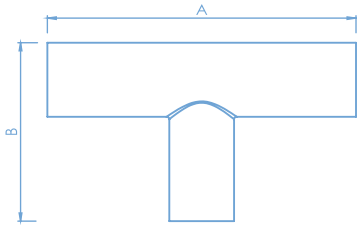

Part Number	Size	A	B
FPRT-4-114X90	114X90	355	215
FPRT-4-90X73	90X73	320	180
FPRT-4-73X60	73X60	265	152
FPRT-4-60X48	60X48	230	130

End Cap – SS 304

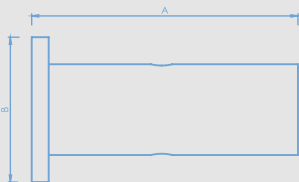

Part Number	Size	A	B
FPEC-4-21	21	72	34
FPEC-4-33	33	75	44
FPEC-4-48	48	80	59
FPEC-4-60	60	83	69
FPEC-4-73	73	96	84
FPEC-4-90	90	109	99
FPEC-4-114	114	117	124

BS-10 Table F Flange Adaptor - SS 304

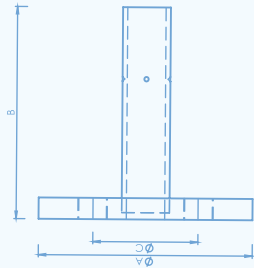

Part Number	Size	A	B	C
FPFA-4-33	33	121	85	87
FPFA-4-48	48	140	95	105
FPFA-4-60	60	165	100	127
FPFA-4-73	73	184	115	146
FPFA-4-90	90	203	125	165
FPFA-4-114	114	229	135	190

BS-10 Table F Reducing Flange Adaptor - SS 304

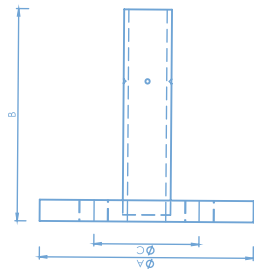

Part Number	Size	A	B	C
FPRFA-4-60X48	60X48	165	95	127
FPRFA-4-73X60	73X60	184	100	146
FPRFA-4-73X48	73X48	184	95	146
FPRFA-4-90X73	90X73	203	115	165
FPRFA-4-90X60	90X60	203	100	165
FPRFA-4-114X90	114X90	229	125	190
FPRFA-4-114X73	114X73	229	115	190

BS-10 Table F Threaded Flange Adaptor - SS 304

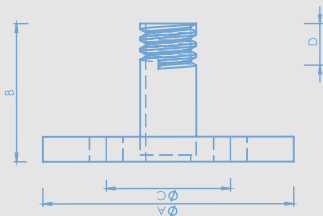

Part Number	Size	A	B	C	D
FPTFA-4-33	33	121	55	87	19
FPTFA-4-48	48	140	60	105	20
FPTFA-4-60	60	165	65	127	24
FPTFA-4-73	73	184	65	146	24
FPTFA-4-90	90	203	65	165	25
FPTFA-4-114	114	229	70	190	25

BS-10 Table F Threaded Reducing Flange Adaptor - SS 304

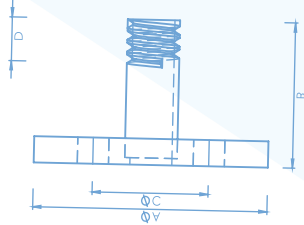

Part Number	Size	A	B	C	D
FPTRFA-4-60X48	60X48	165	60	127	20
FPTRFA-4-73X60	73X60	184	65	146	24
FPTRFA-4-73X48	73X48	184	60	146	20
FPTRFA-4-90X73	90X73	203	65	165	24
FPTRFA-4-90X60	90X60	203	65	165	24
FPTRFA-4-114X90	114X90	229	65	190	25
FPTRFA-4-114X73	114X73	229	65	190	24

Reducing Bush Male & Female – SS 304

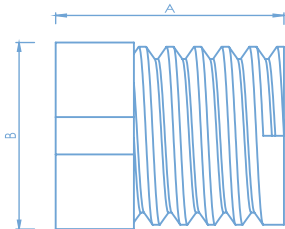

Part Number	Size	A	B
FPRB-4-27X21	27X21	35	30
FPRB-4-27X33	27X33	35	35
FPRB-4-33X21	33X21	35	35
FPRB-4-48X33	48X33	40	50
FPRB-4-48X21	48X21	40	50
FPRB-4-60X48	60X48	45	65
FPRB-4-60X33	60X33	45	65
FPRB-4-60X21	60X21	45	65
FPRB-4-73X60	73X60	45	75
FPRB-4-73X48	73X48	45	75
FPRB-4-73X33	73X33	45	75
FPRB-4-27X21	27X21	45	75

Double Nipple – SS 304



Part Number	Size	Length
FPDN-4-21	21	65
FPDN-4-33	33	70
FPDN-4-48	48	75
FPDN-4-60	60	80

Line Reducer – SS 304

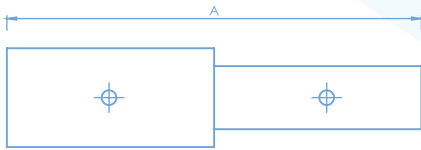
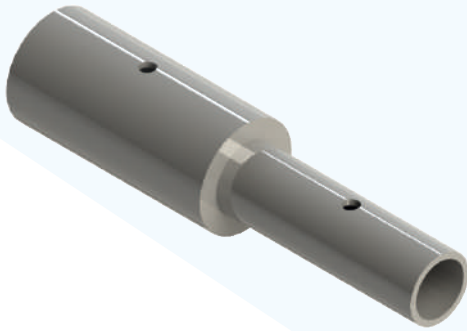

Part Number	Size	A
FPLR-4-33X21	33X21	110
FPLR-4-48X33	48X33	115
FPLR-4-60X48	60X48	125
FPLR-4-60X33	60X33	120
FPLR-4-73X60	73X60	140
FPLR-4-73X48	73X48	135
FPLR-4-90X73	90X73	160
FPLR-4-90X60	90X60	150
FPLR-4-90X48	90X48	145
FPLR-4-114X90	114X90	175
FPLR-4-114X73	114X73	165
FPLR-4-114X60	114X60	155
FPLR-4-114X48	114X48	150

Saddle Branch – SS 304

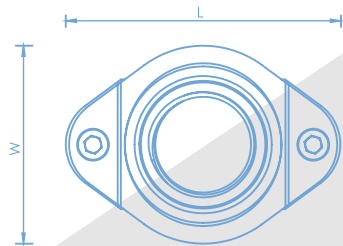

Part Number	Size	L	W
FPSB-4-33X21	33X21	69	45
FPSB-4-48X33	48X33	84	62
FPSB-4-60X33	60X33	103	65
FPSB-4-73X48	73X48	118	80
FPSB-4-90X60	90X60	144	95
FPSB-4-114X73	114X73	175	115

Barrel Nipple – SS 304

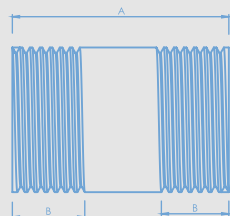
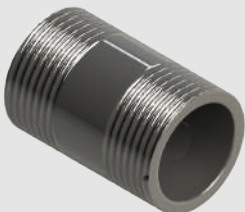

Part Number	Size	A	B
FPBN-4-33	33	50	16
FPBN-4-48	48	70	19
FPBN-4-60	60	90	25

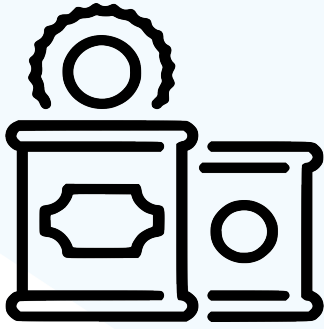

FOOD

BEVERAGE



OIL & GAS

CHEMICAL

